

TSE Ergonomic Kiosks

Rugged ergonomic kiosk computer with NEMA protection for operator interface applications in industrial environments.

The ergonomic kiosk has a friendly operator interface design and several rugged keyboard options to best suit your application and environment.

This rugged ergonomic workstation is an ideal solution for process control and monitoring of industrial operations such as factory automation, oil refining, chemical processing, power generating plants, or work environments that require regular washdown of equipment with uninterrupted operation.



TSE standard in stainless steel or black powder coated aluminum. Custom colored powder coating available.

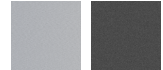

Standard Features:

- Industrial-grade LED back-lit LCD
- Mounting configuration: pedestal, mounting tabs, and swing arm/swivel
- Construction/environmental design: fully sealed, NEMA 4X (IP66) 316 stainless steel or NEMA 4 (IP65) powder coated aluminum enclosure
- Hinged front enclosure door with quarter-turn cam locks
- Power input: 12 VDC, 9-36 VDC or 90-264 VAC internal power supply
- I/O connection type: sealed IP68 general purpose connectors
- Operating temperature: -20° to 60° C (Extreme Temperature Package available depending on size. Please inquire.)
- Relative humidity: ≤ 0% to ≤ 90%

- Altitude: 10,000 ft MSL
- 2-year warranty

Computer Features:

- Embedded computer
- Solid-state components
- Available touchscreens: resistive, PCAP, and ArmorTouch
- Operating system: Windows 10 Professional 64-bit (standard)
- 2 × 10/100/1000 Mbps LAN

Dimensions (W × H × D) and Specification Chart:

| Size | Enclosure Dimensions | Brightness | Resolution | Touchscreen* | Viewing Angle | Contrast | Aspect Ratio | Power Consumption (Calculated at 12 V DC) | Approx. Weight** (Stainless Steel) | Approx. Weight** (Aluminum) |
|------------|------------------------|-------------------------|--------------------------------------|--------------|------------------------------------|------------------|--------------|--|---------------------------------------|--------------------------------|
| 15" | 24.5" × 24.2" × 14.75" | 400 nits 1500 nits ☀ | XGA 1024 × 768 XGA 1024 × 768 | Res/PCAP/AT | 80°/80°/80°/80° 80°/80°/60°/80° | 600:1 800:1 | 4:3 | ≈ 12 W ≈ 47 W | ≈ 62 Lbs | ≈ 42 Lbs |
| 17" | 24.5" × 24.2" × 14.75" | 350 nits 1000 nits ☀ | SXGA 1280 × 1024 SXGA 1280 × 1024 | Res/PCAP/AT | 80°/80°/60°/80° 80°/80°/60°/80° | 800:1 1000:1 | 5:4 | ≈ 25 W ≈ 62 W | ≈ 65 Lbs | ≈ 45 Lbs |
| 19" | 24.5" × 24.2" × 14.75" | 350 nits 1600 nits ☀ | SXGA 1280 × 1024 SXGA 1280 × 1024 | Res/PCAP/AT | 85°/85°/80°/80° 85°/85°/80°/80° | 1000:1 1000:1 | 5:4 | ≈ 20 W ≈ 60 W | ≈ 67 Lbs | ≈ 47 Lbs |
| 21.5" wide | 24.5" × 24.2" × 14.75" | 300 nits 1500 nits ☀ | FHD 1920 × 1080 FHD 1920 × 1080 | Res/PCAP/AT | 89°/89°/89°/89° 89°/89°/89°/89° | 5000:1 1000:1 | 16:9 | ≈ 24 W ≈ 42 W | ≈ 70 Lbs | ≈ 50 Lbs |

☀ Sunlight readable LCD

** Weight may differ based on overall configuration

* Res - resistive touch, PCAP - projective capacitive touch, and AT - ArmorTouch glass-on-film resistive touch

Standard I/O Connectors: bottom or rear exit connectors

Sealed IP68: general purpose connector for ToughStation fully sealed series

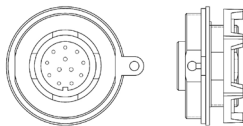

Sealing hub with gasket and locknut: used in our general purpose and hazardous area workstations

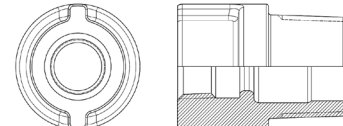

Available Ruggedized I/O Connectors:

M8/M12/M23: industrial automation, vibration and shock-resistant

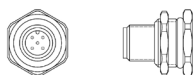

MIL-DTL 38999: military standard, sealed, vibration and shock-resistant quick-coupling circular locking connectors

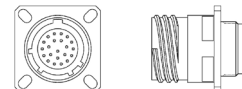

LCD Controller Board Specifications:

| Option | Resolution | Available Video I/O Ports | Horizontal/Vertical Scan |
|--------|---------------------------|--|--------------------------|
| A* | Up to 1440 × 900, 8-bit | 1 × DVI, 1 × VGA | 60 Hz up to 1440 × 900 |
| B* | Up to 1600 × 1200, 8-bit | 1 × DVI, 1 × VGA, 1 × Composite (PAL/NTSC) | 60 Hz up to 1600 × 1200 |
| C | Up to 1920 × 1200, 8-Bit | 1 × HDMI, 1 × Display Port, 1 × VGA | 60 Hz up to 1920 × 1200 |
| D | Up to 1920 × 1200, 10-bit | 1 × HDMI, 1 × DVI, 1 × VGA 1 × Composite (PAL/NTSC) | 60 Hz up to 1920 × 1200 |

Non-standard controller boards and I/O ports available depending on panel size. Please inquire.
* Not compatible with FHD screen resolution

Standard Motherboard Specifications:

| Option | Processor | Memory | Storage Drive | Operating System | Available I/O Ports |
|--------|---|-------------|-------------------------------|--|---|
| C | Intel Atom E3845 | Up to 8 GB | 1 × SATA-300 1 × CFAST | Win 7: 32/64-bit, Win 10: 32/64-bit | 2 × RS-232/422/485 3 × USB 2.0 1 × LAN |
| D | Intel J1900 Quad-Core | Up to 8 GB | 1 × SATA-300 1 × CFAST | Win 7: 32/64-bit, Win 10: 32/64-bit | 2 × RS-232/422/485 3 × USB 2.0 1 × LAN |
| E | i5-7300U | Up to 16 GB | 1 × SATA-300 1 × mSATA/SIM | Win 10: 64-bit | 2 × RS-232/422/485 4 × USB 3.0 2 × LAN |
| F | Celeron G3900TE, i3-6100TE, i5-6500TE, i7-6700TE | Up to 32 GB | 1 × SATA-600 | Win 10: 64-bit | 1 × RS-232/422/485 3 × USB 3.0 1 × USB 2.0 2 × LAN |

Non-standard motherboards and processors available depending on panel size. Please inquire.
Motherboard selection may affect operational temperature

Available Options:

- Optical bonding (VBOND): adhering a cover glass, protective overlay, or touchscreen to the front surface of the LCD using an optical-grade silicone to increase solar reflectivity and ruggedness.
- Wide temperature LCD panel
- Harsh duty video controller board or motherboard/SSD/RAM
- Extreme temperature: -20° to 70°C (-4° to 158°F) available for select builds. Please inquire.

Environmental Functional Upgrade Packages available. See below.

Computer Options:

- System memory: 4 GB to 32 GB (depending on the motherboard)
- Storage: HDD, SSD, removable drives, various capacities, multiple drives
- Operating system: Windows 10 Professional – 32 & 64-bit, Windows 10 Enterprise, Windows 7 – 32 & 64-bit, Linux (select versions of Linux supported)
- Additional and/or alternate I/O ports available: Please contact your sales representative

Monitor Options:

- Available touchscreens: resistive, PCAP, and ArmorTouch
 - Touchscreen interface: USB, or serial connections
- All available options are subject to mechanical design limitations. Please inquire.

Mounting Option Examples:

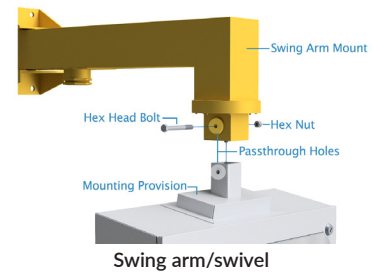
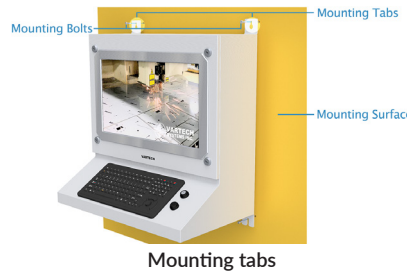
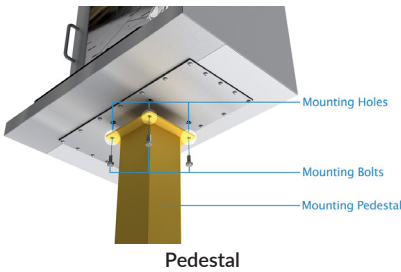

Environmental Functional Upgrade Packages:

VarTech's Environmental Functional Upgrade Packages allow for custom COTS solutions using standard feature sets.

| High Bright Sunlight Readable Package | Extreme Temperature Package (-40° C to 70° C) | Vandal/Impact Resistant Package |
|--|--|--|
| <ul style="list-style-type: none"> • High luminance LED backlights • Proprietary optical film stack • Optical bonding of protective window or touchscreen to LCD • Anti-reflective coatings • Brightness levels ranging from 700 nits to 1500 nits (depending on screen size) • Dimming: Manual dimmer dial – 1000:1 dimming ratio, or auto-dimming • Optional: backlight kill switch | <ul style="list-style-type: none"> • Integrated heater and thermostat • Wide temperature LCD panel • Harsh environment video controller board or motherboard/SSD/RAM • Optional: heat-reflective powder coat • Optional: uninterrupted wide temperature dual Power Supply Unit (PSU) system | <ul style="list-style-type: none"> • Impact resistant protective overlay glass • 8H abrasion-resistant overlay glass • Chemical and stain resistant glass and surfaces • Tamper-proof conduit connectors • Optional: PCAP touchscreen |

ToughStation Workstation Core Model Number Breakdown:

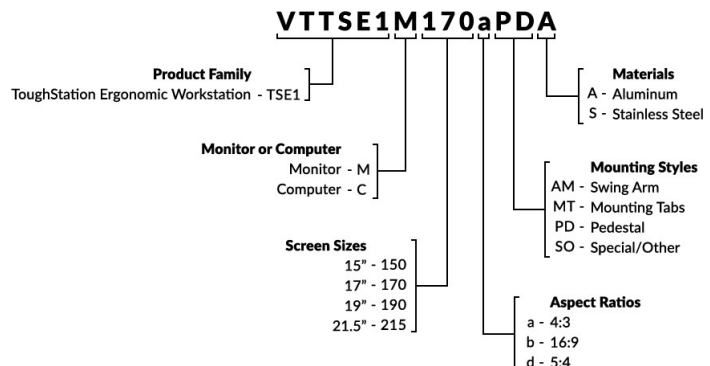

9-37 Currans Road, Cooranbong, NSW 2265
+61 (0)2 4977 3511
unisales@unitronix.com.au www.unitronix.com.au

Over 30 Years of Rugged HMI and Industrial Computer Manufacturing Experience



VARTECH Systems, 11422 Industriplex Blvd. Baton Rouge, Louisiana 70809 | vartechsystems.com
US & Canada: 800-223-8050 | International: 001-225-298-0300 | sales@vartechsystems.com